

Röckelein
Noppenbetonstein
l=50 b=50 h=25 mit 4 Noppen

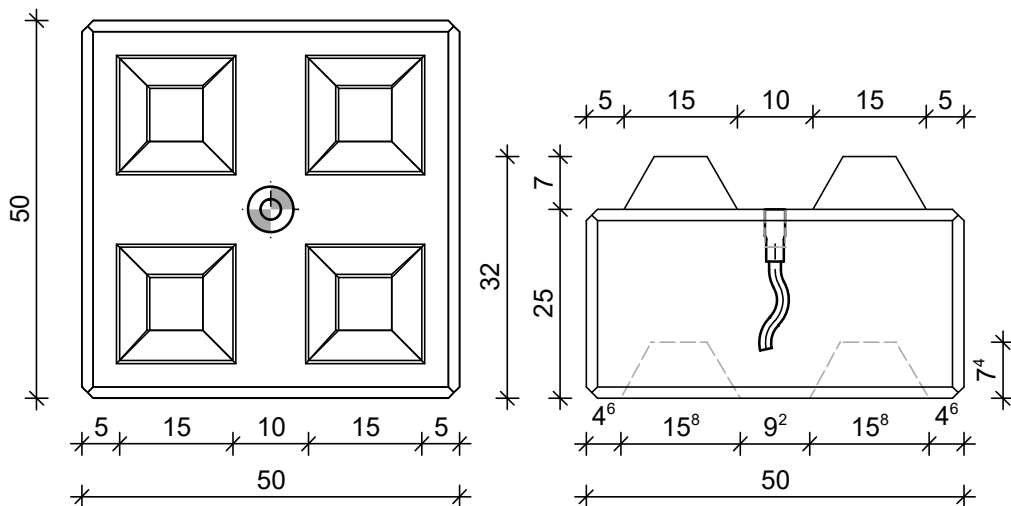
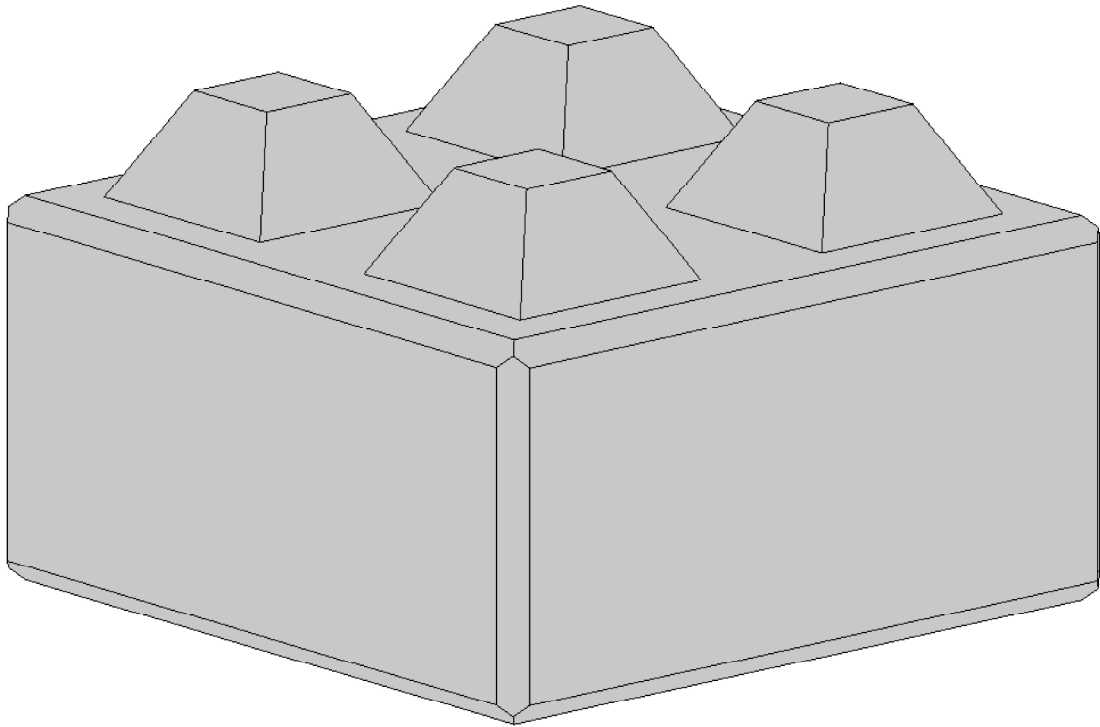

Dreikantleiste:
1,5cm um den
Betonblockstein